

①



1PC

②



1PC





③

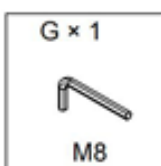
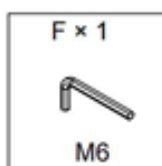
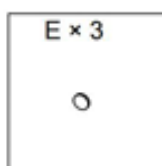
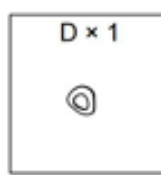
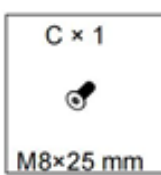
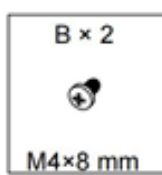
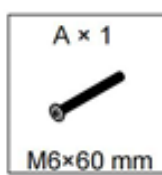

1PC



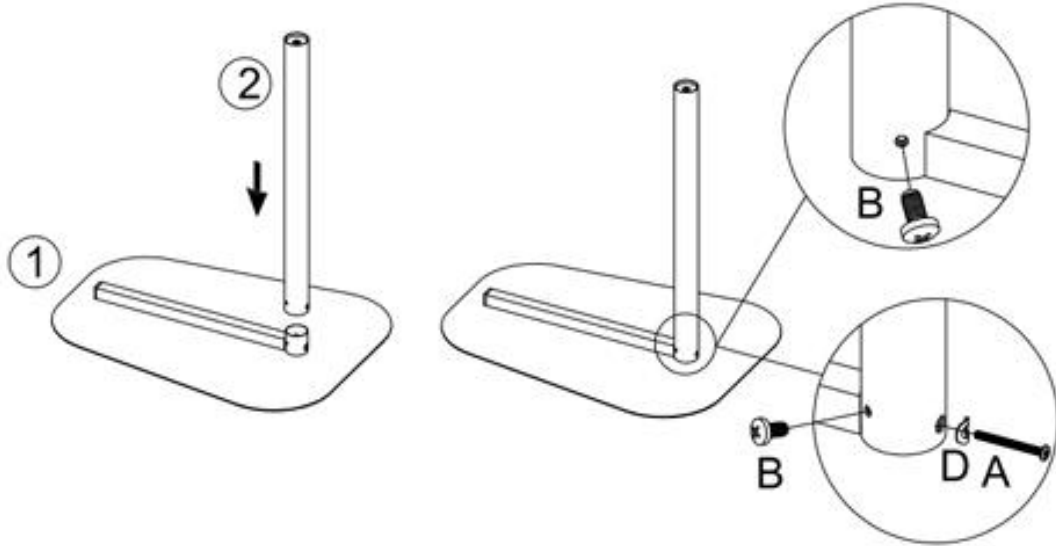

1

A × 1  M6×60 mm	B × 2  M4×8 mm	D × 1 	F × 1  M6
--	---	--	--



2

C × 1  M8×25 mm	G × 1  M8
--	--

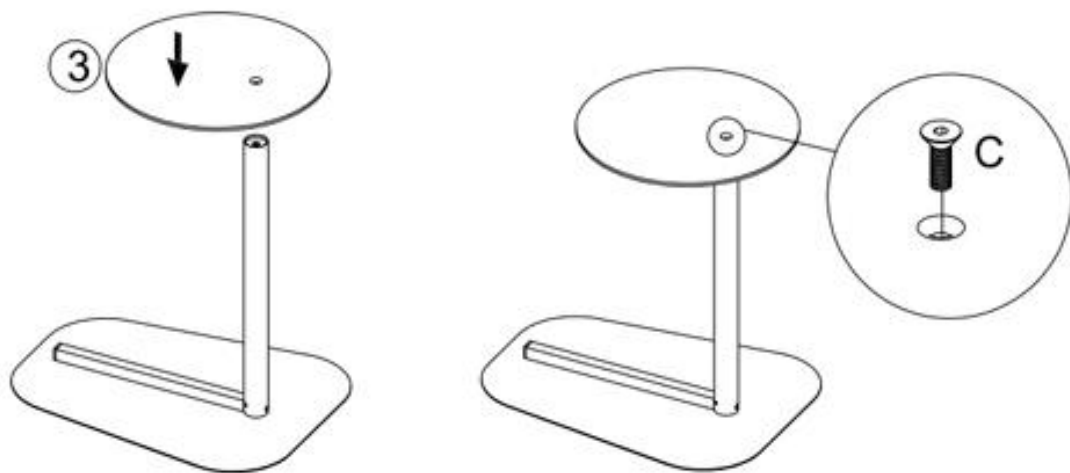

3

E×3  
○

